



PULSE Freestanding Tub

Model # PT-1051-BN & PT-1051-CH

Specification Sheet

297 Anna St. | Watsonville, CA 95076
 831.724.7300
 www.PulseShowerSpas.com



TECHNICAL INFORMATION

- Installation: Freestanding
- Color: Polished White Acrylic
- Max Weight: 1102.31LBS (500kg)
- Product Weight: 77 lbs
- Water Capacity: 50.73 gal
- Box Dims: 31"x31"x70"
- Drain Location: Center
- Drain Finishes: Chrome or Brushed Nickel

PRODUCT FEATURES

- 100% polished white acrylic material
- Bathtub with waste/overflow and brass pop-up drainage
- Waste & drain finishes available in chrome or brushed nickel
- Integral Slotted overflow allows for deep soaking
- Center toe-tap drain

NOTES

- Measure your actual product for rough-in details
- Install this product according to the installation instructions
- Allow for 3" (76mm) diameter of clearance around the drain pipe on finished floor material to prevent drain body interference during installation

CODE/STANDARDS

- cUPC Approved

WARRANTY

- 5 Years

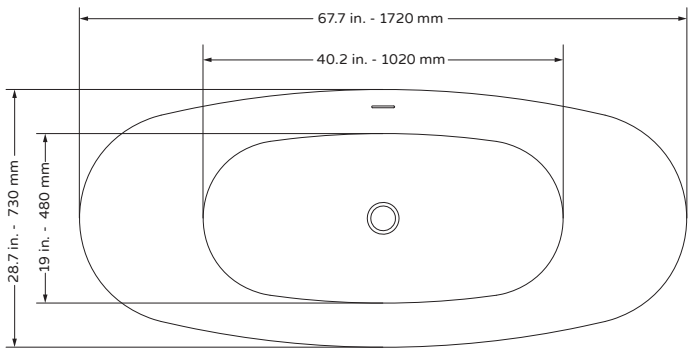
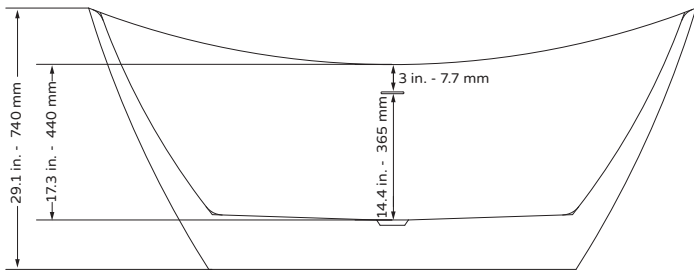

POP-UP DRAIN

